



Unmatched Performance in Commercial Kitchens

Professional chefs and culinary schools around the world trust the Vita-Prep 3 for its exceptional power, versatility, and performance. From chopping delicate ingredients to blending tough purées, the Vita-Prep 3 provides the power and dependability required in the most demanding kitchens.

Smart Product Design

- ≈3 peak output HP motor features improved thermal protection, providing the power and dependability required in the most demanding commercial kitchens
- Variable Speed Control and Tamper allow for control and easy processing of dense ingredients
- Sturdy, intuitive controls minimize training time and provide improved grip
- Advanced cooling fan provides optimum reliability during peak hours of operation
- BPA-free, high-impact 2.0-liter container has a removable lid plug to easily add ingredients while blending

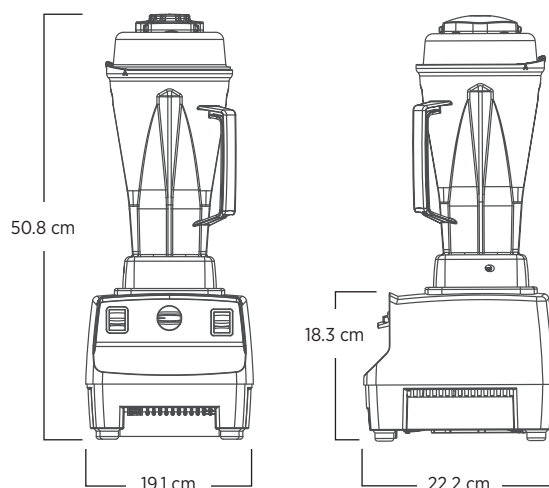

Includes Vita-Prep 3 with 2.0-liter high-impact, clear standard container complete with Wet blade assembly and lid, tamper, and black base.

For more complete warranty terms and conditions, please contact your authorized Vitamix distributor.

Product Specifications

Motor	≈3 peak output horsepower motor		
Electrical	220-240 V, 50-60 Hz, 1200-1400 W	Taiwan: 120 V, 60 Hz, 1500 W	Japan: 100 V, 50-60 Hz, 975 W
Net Weight	5.73 kg (6.73 kg with box)		
Dimensions	50.8 x 19.1 x 22.2 cm (HxWxD)		

Also Available

- 2.0 L BPA-free, clear standard container complete with Wet blade assembly and lid

- 1.4 L BPA-free, clear standard container complete with Wet blade assembly and lid

- 0.9 L BPA-free, clear standard container complete with Wet blade assembly and lid

- 0.9 L BPA-free, compact, clear/stackable container with aerating blade assembly, lid and mini tamper

Not all products are offered in all countries. Products and item numbers may differ in your local market. Please contact your Vitamix Account Representative for product availability and item details.

Contact Information

Commercial Sales

+1 440.782.2450
international@vitamix.com

Technical Support

+1 440.782.2450
commercialts@vitamix.com



vitamix.com

For more information, please contact an authorized Vitamix distributor, or Vitamix international customer service.